



# SLABlite<sup>TM</sup>

Quick-Start Reference

April 1, 2018

## Thank you for purchasing SLABlite Panels

SLABlite Panels are the ultimate solution to back-lighting stones like onyx, solid surface translucent materials for countertops and other back lighting challenges. This energy efficient product is waterproof, durable and provides consistent even lighting for many surfaces with an expected life of 20 years. The SLABlite can be custom cut on the jobsite.

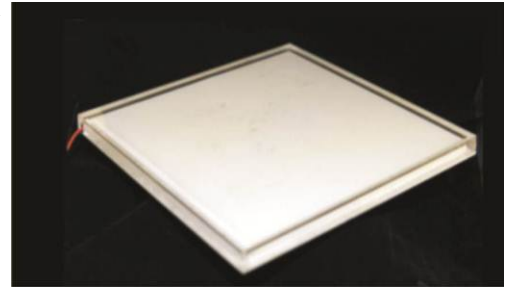

### SLABlite Tile Specifications:

- Dimensions 12.0" x 12.0" X 0.375"
- Voltage 12VDC
- Power 1.92 watts per panel
- Draw .16 amps per panel @ 12VDC

## Working with the SLABlite Panel

The Reference Direction (RD) refers to the location of the LED light strip to the panels orientation. The flow of light from the LED light strip determines the correct orientation of the panel.

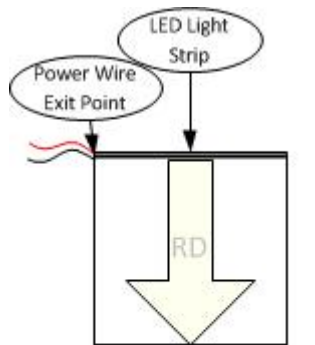

RD Arrow =  
Indicates the Tiles  
Reference Direction  
**Figure 2**

Panels should be installed right next to each other with no gaps to avoided shadows.

Do not install two panels with light strips touching as this will result in a dark unlit strip where the panels meet.

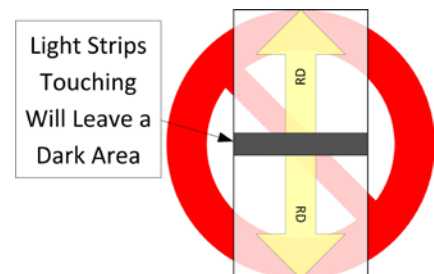

Unacceptable Layout

**Figure 1**

## Cutting SLABlite Panels

SLABlite panels can be cut to work around shapes like sinks curved countertops. SLABlites should be cut on one of the 3 - sides away from the “Light-Strip” whenever possible. Contact SLABlite Inc if your layout requires the Light-Strip to be cut.

Figure 3 below illustrates safe cuts or acceptable cuts to the SLABlite in the left and center diagrams and an unacceptable cut on the far right. It is recommended that you layout the SLABlites so it is not necessary to cut the Light-Strip edge if possible.

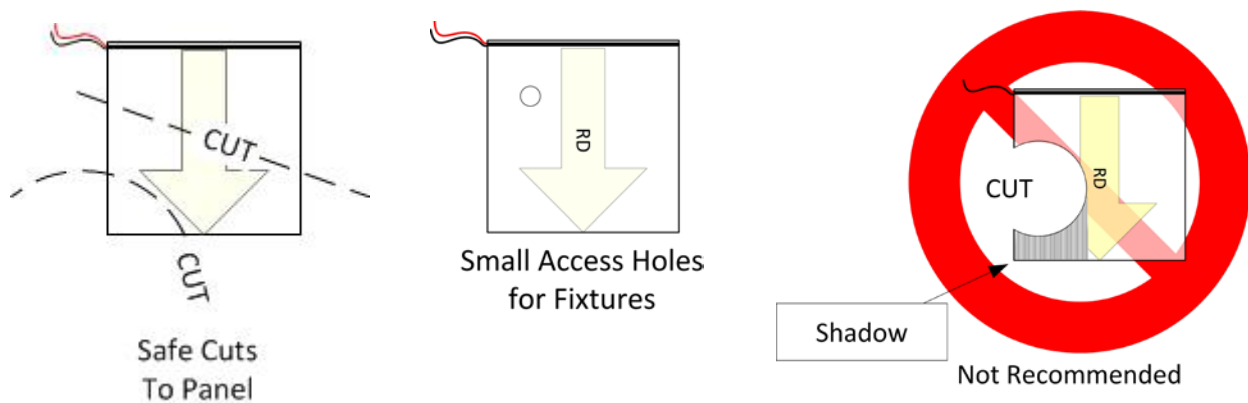

Figure 3

The SLABlite panel is an encapsulated light guide. The LEDs project light across a printed or molded pattern and then the light is guided towards the face of the panel at 90%. If you need to cut one SLABlite within 3 inches of the LED light-strip the SLABlite might be slightly brighter than the other SLABlites. It would be best to split the distance between two SLABlites equally.

The SLABlite panel is encapsulated and waterproof. If you cut the SLABlite, the SLABlite must be resealed. You can reseal the SLABlite simply by applying silicone to the edge that you cut. Apply the silicone making sure to seal the edge. Allow 24 hours to cur. You can keep working, just put the SLABlite in place and let it cur.

The SLABlite can be cut with a Skil circular saw, table saw, jigsaw, bandsaw using a fine-tooth blade. Or a router can be use with a wood bit.

The SLABlite panel light-strip edge can be cut. Every inch there are three LEDs wired in series, and then this group of LEDs is wired in parallel with the other groups. If you cut into the single group of LEDs, they will all fail to light, and you will lose light back to the next cut line. Please review figures 4a, 4b, and 4c to see where you can cut.

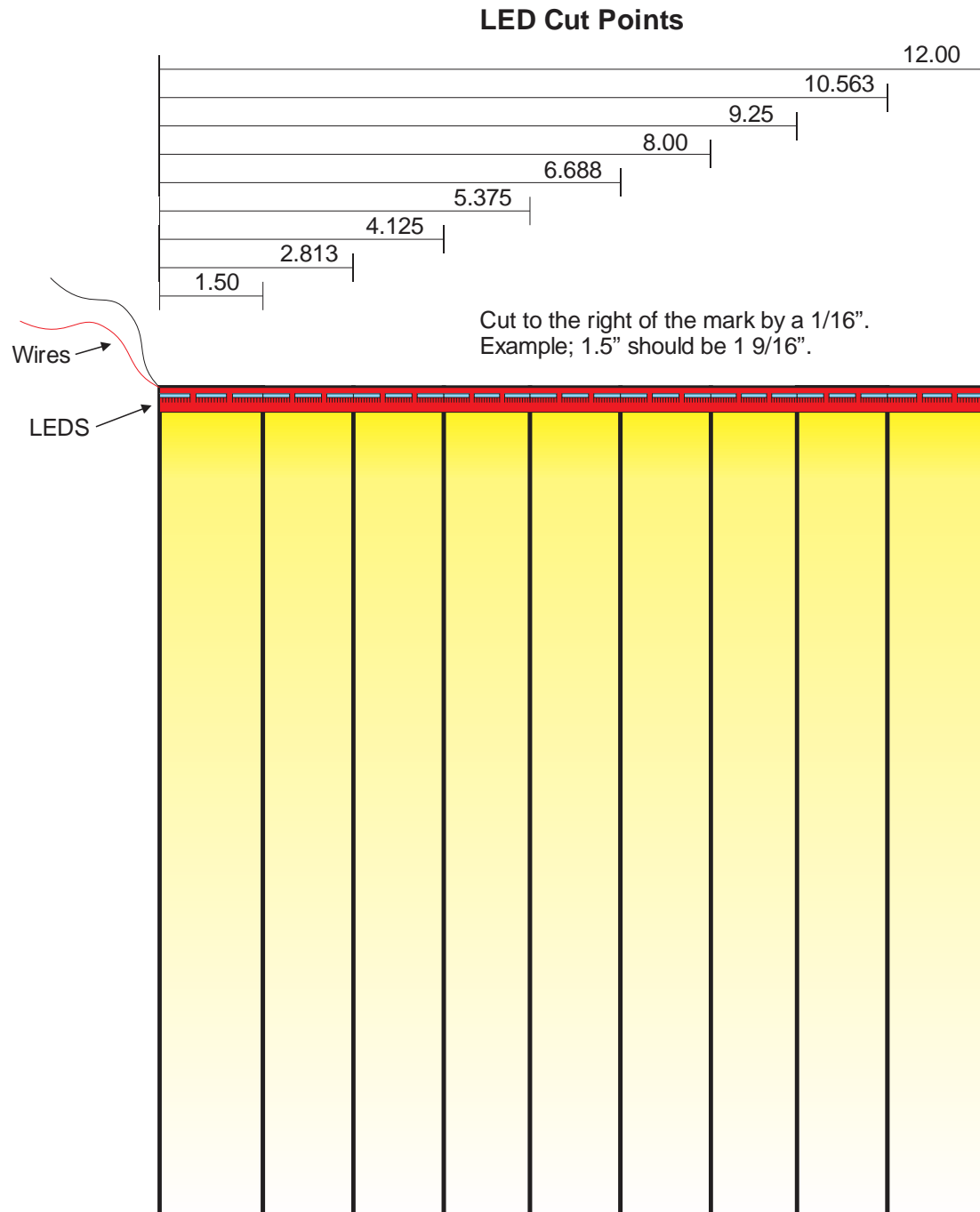

Figure 4a

### LED Cut Points

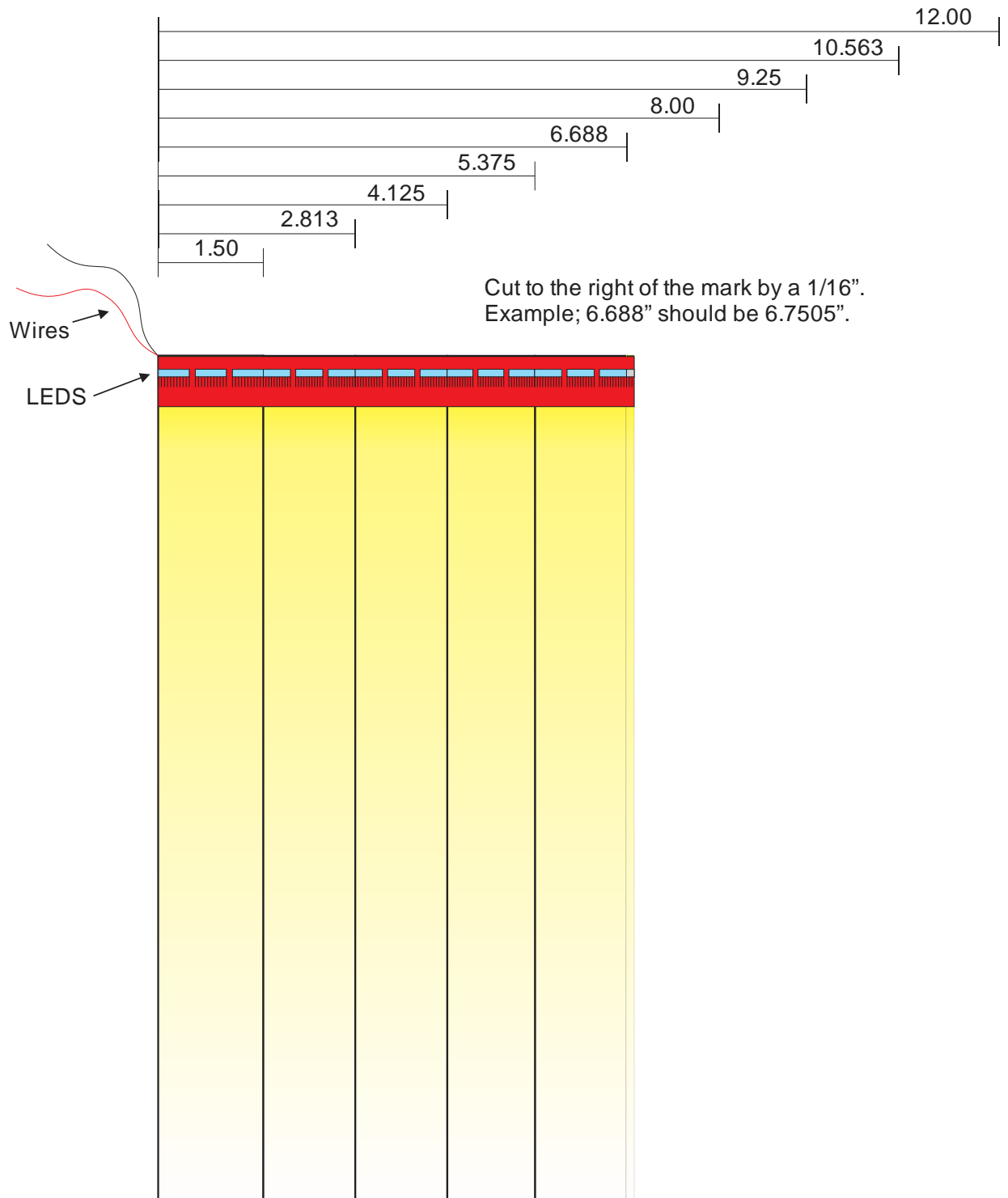

Figure 4b

# LED Cut Points

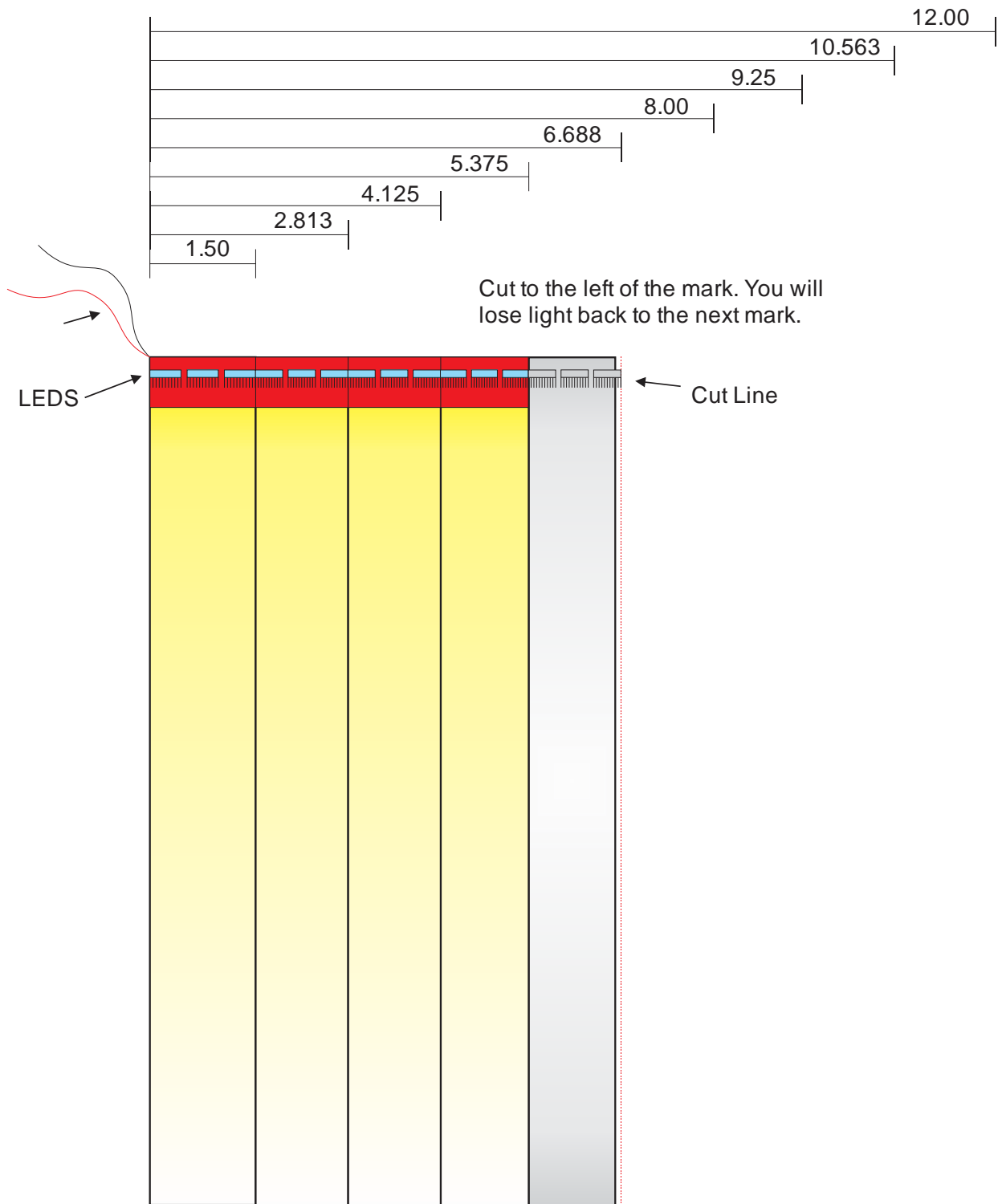
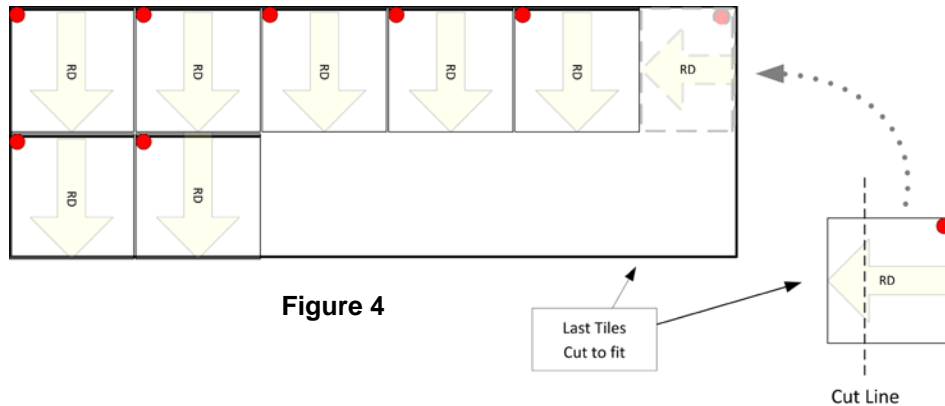

Figure 4c

## SLABlite Layout

Figure 4 shows a typical layout with a return on each side. Red dots indicate wire location on each tile. For more information on **sample layouts** see our website.



Cut Channels for wire and connections.

A paddle bit may be used to create a larger pocket in the substrate to conceal the wire and connectors at each panel location.

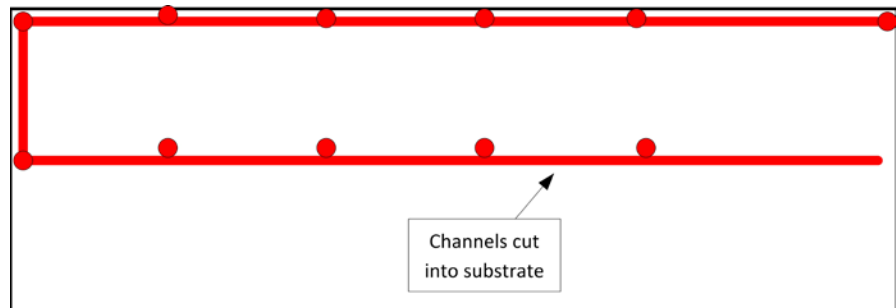

Figure 5

## Substrate and Cabinet Considerations

SLABlite panels require a clean firm and solid surface to be adhered too. The SLABlite panels are fitted much like 12 X 12 ceramic panels while paying attention to the reference direction.

## Electrical Requirements

SLABlites require 12VDC to power the proprietary LED Light Strip. Proper protection of the DC Circuit is important to insure the life of the panels. A 60-Watt LED driver (power supply) is recommended for up to 24 Panels. Calculate proper fuse size based on .16 amps per panel @ 12VDC. **A 4.0-amp fuse is required for 24 SLABlites.**

A typical power plan might look like the diagram below

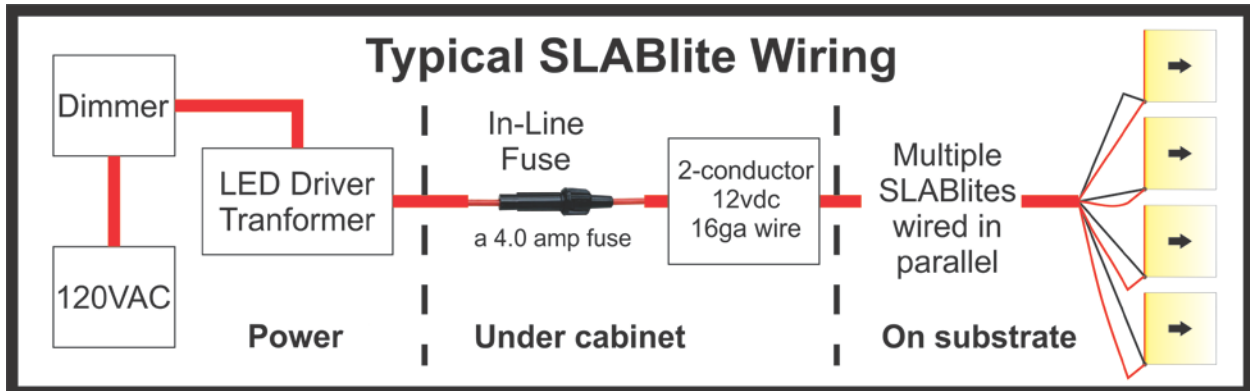

Figure 6

A typical power plan might look like the diagram below.

## Wiring

SLABlite panels are to be wired in parallel. Wiring may be completed with 16/18AWG stranded or solid copper. Insulation Displacement Connections (IDC) like 3M's Scotchlok, or insulated soldered joints may be used.

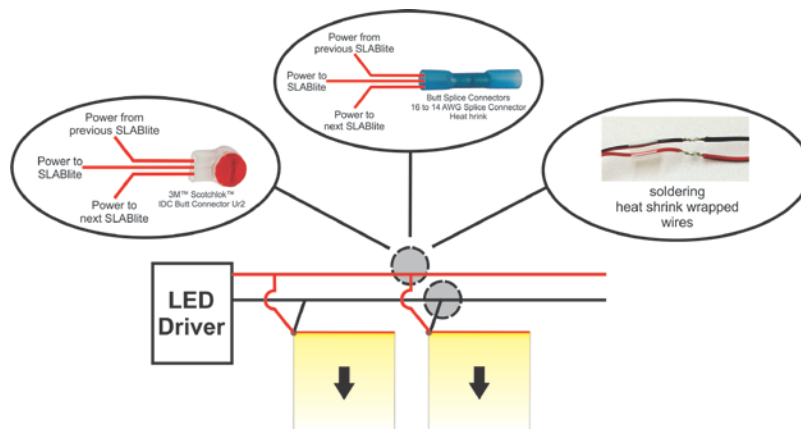

Figure 7



## Setting / Wiring Panels

Once the layout is decided upon its time to wire, test and adhere the panels to the substrate.



**Figure 8**  
12VDC to substrate



**Figure 9**  
Connector / wires secured with hot glue



**Figure 10**  
SLABlite tested, glued in place



**Figure 11**  
Fixture and sink cutouts



**Figure 12**  
Installed counter SLABlite panels

## Counter Top Surface

Caution is advised during the placement of the countertop. SLABlite, Inc. recommends the use of DAP DYNAFLEX 230 **CLEAR** sealant to adhere the counter top to the SLABLites.

It is important to keep the SLABlite panels lit during the installation of the counter top surface to insure no connections are disrupted or panels are damaged during the installation.